



# HOTWIRE INSTRUCTIONS

**MODEL: HWTS1 WIFI**

*WiFi Thermostat*



**CONGRATULATIONS  
ON THE PURCHASE OF  
YOUR **NEW HOTWIRE**  
**THERMOSTAT.****

This guide will help you program your thermostat to get maximum value from your new floor heating system.



Scan for Video Manual



- Step 1** Download TUYA Smartlife App
- Step 2** Press the + button at the top right and "Add Device"
- Step 3** Go to Menu 22 in Advanced Settings and Select "App Mode"
- Step 4** The Thermostat will be located.
- Step 5** Scan the QR code to watch the video on how to use the Thermostat.

## SELECT HORIZONTAL OR VERTICAL OPERATION



Press **menu**, then press "Direction" to select **Horizontal** or **Vertical**.

## SET TIME AND DAY



Press **Menu**  
Then press  
**"Time"**.

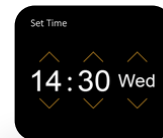

Use the **up** and **down** arrows to set the correct time and day.

## MANUAL / AUTO / HOLIDAY MODE

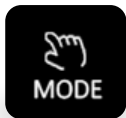

For **Manual operation** Press **"Mode"** until the **"Hand"** symbol is displayed.

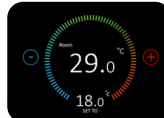

Then use the **- and +** buttons either side of the temperature to increase or decrease the set temperature.



For **Auto** press **"Mode"** until this symbol is displayed.

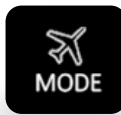

For **Holiday** press **"Mode"** until a plane is displayed. *(Holiday duration can be set in advanced settings)*

## PROGRAM YOUR FLOOR HEATING.



Press **"Menu"** then **"Edit setting"**

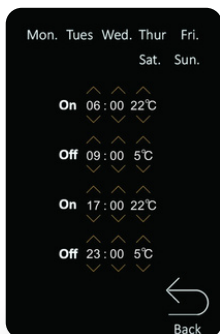

Your thermostat can turn on and off twice every day.

The first **"On"** time is when you want your heating to turn on each morning.

The first **"Off"** time is when you want your heating to turn off each morning.

Use the **up** and **down** arrows to set the correct time and temperature.

**NOTE:** The temperature at "Off" time is maintained. Set to approximately 16°C to prevent cold floors, or 5°C to keep heating turned off.

Repeat for the on and off in the evening. If you don't want your heating in the evening just set the on and off times to be only 1 minute apart.

**NOTE:** Your heating is set to 5-1-1 (same schedule weekdays, different on weekends). For a daily schedule, go to Menu > Advanced Settings > Option 5, then change to 7.

### AUSTRALIA

1300 **HOTWIRE**  
hello@hotwireheating.com.au  
www.hotwireheating.com.au

### NEW ZEALAND

0800 **HEATING (432 846)**  
info@theheatingcompany.co.nz  
www.theheatingcompany.co.nz

## KEY LOCK



Press  
"Menu" then  
select  
Keylock.  
To Unlock,  
repeat.

## Advanced Settings

Changing some of the following settings can negatively affect your floor heating if not adjusted correctly.  
If you are unsure please check with your Hotwire Installer.

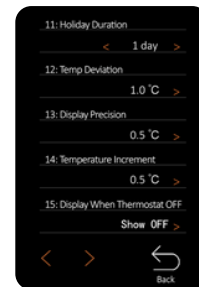

## TECHNICAL DATA

**Voltage:** 110/230V~50/60Hz

**UFH Relay:** Max.16A(Resistive load) Floor Heating

**Floor Sensor Type:** 3K 5K 6.8K 10K (default) 12K 15K 20K 22K 33K 47K 50K 100K

**Temperature range:**

**Room Temperature:** 5-60°C

**Floor Temperature Limit:** 5-60°C

**On/Off Differential:** ±0.5,1,2,3°C

**Storage temperature:** -10-50°C

**IP Class:** IP21

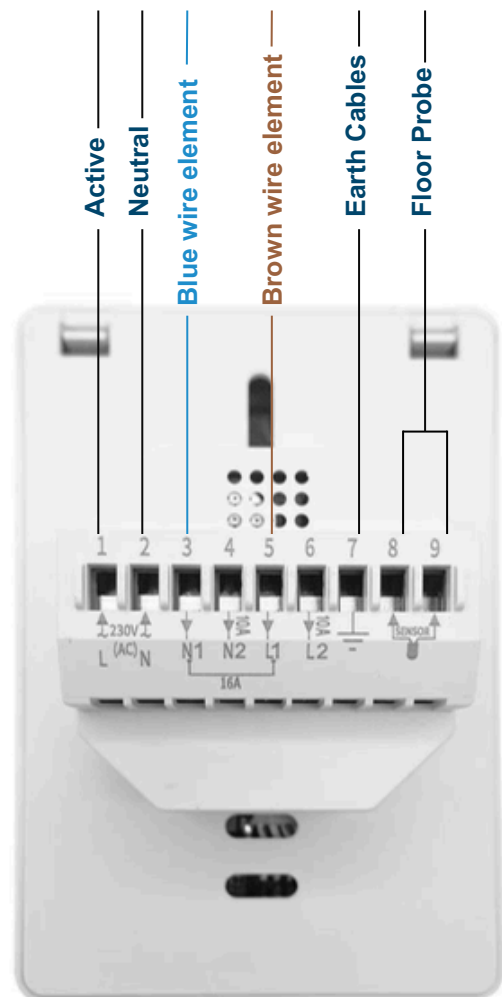

### AUSTRALIA

1300 HOTWIRE  
hello@hotwireheating.com.au  
www.hotwireheating.com.au

### NEW ZEALAND

0800 HEATING (432 846)  
info@theheatingcompany.co.nz  
www.theheatingcompany.co.nz

## Advanced Settings function explanation

Changing some of the following settings can negatively affect your floor heating.  
If you are unsure please check with your Hotwire Installer before adjusting.

Item	Default	Options	Explanation
01: Sensor Selection	Room	Room/Floor/All	Select the sensor.
02: Room Temperature Calibration	0°C	-5°C - 5°C	Adjust room sensor
03: Floor Sensor Calibration	0°C	-5°C - 5°C	Adjust floor sensor
04: Max Floor Temperature	35°C	5°C - 60°C	Set the maximum floor Temperature. Floor heating will not normally exceed 30°C
05: Schedule	5-1-1	5-1-1/7	Schedule program settings to the same each day or different on the weekend.
06: Adaptive Start	Off	On / Off	Adaptive start will override your program settings and turn the heating on earlier if the set temp will not be reached.
07: Adaptive Start Time	20	0-40 Mins	Set the time for adaptive start.
08: Open Window	Off	On/Off	Allow your heating to adapt to an open window.
09: Sensor Type	10K	3, 5, 6.8, <b>10 default</b> , 12, 15, 20, 22, 33, 47, 50, 100 (K)	Set the reading of the floor probe.
10: Anti Freeze Function	Off	On/Off	Set your heating to avoid a freezing floor.
11. Holiday Duration	1 day	99 Days	Set the length of your holiday to pause your heating.
12.Temp Deviation	1°C	0.5, 1, 2, 3°C	
13. Display Precision	0.5°C	0.5, 0.1°C	Adjust the accuracy of display
14. Temperature Increment	0.5°C	0.5, 0.1, 1°C	Adjust the change of increment.
15. Display when off	Off	Off/Show Temp/Nothing	What shows on display when off.
16. Temperature Unit	°C	°C or °F	Adjust from Celsius to Farenheit
17. Restart state after power off	Keep	Keep/On/Off	
18. Rail Control Time	1	1, 2, 4, Hold	Length of time for manual setting for towel rail
19. Brightness	100%	30-100%	Adjust the brightness of the display
20. Factory Reset	No	No/Yes	Completely reset to factory settings
21. Horizontal display	Off	Off/On	Adjust thermostat orientation

### AUSTRALIA

1300 **HOTWIRE**  
hello@hotwireheating.com.au  
www.hotwireheating.com.au

### NEW ZEALAND

0800 **HEATING (432 846)**  
info@theheatingcompany.co.nz  
www.theheatingcompany.co.nz